



MAX S2

S2-10D1/S2-10D2/S2-12D1/
S2-12D2/S2-15D1/S2-15D2

HARDCORE CAR AUDIO

MAX USER MANUAL

WE PLAY LOUD!!

We know what you want. You want it LOUD, and that is exactly what we do, what we live for. Vibrations, gut-punches and straight up loud music - that's what makes us tick. We won't dress up in fancy words or claim to be something we're not. We are the NO BULLSH!T car audio brand!











Every single product with the GAS logo on it is born out of passion, the same that has driven us for two generations and that will keep us rolling up to your neighbourhood, winning and pushing the limits for many generations to come!

It's up to you to choose your own level of loud, and if you don't like what we do that's OK. You are welcome back when you've had your first true GAS experience. We don't exclude, we don't judge and we do not make up any excuses for who we are.

We are GAS and we are proud to be LOUD!

GAS

TABLE OF CONTENT

	SAFETY.....	3
	UNPACKING.....	4
	DIMENSIONS.....	4
	SPECIFICATIONS.....	5
	MAX S2-10D1.....	5
	MAX S2-10D2.....	5
	MAX S2-12D1.....	6
	MAX S2-12D2.....	6
	MAX S2-15D1.....	7
	MAX S2-15D2.....	7
	PERFORMANCE.....	8
	Thiele/Small parameters.....	8
	Impedance vs frequency.....	10
	FEATURES.....	12
	This is what real bass feels like.....	12
	Truly next level.....	12
	Impressive in every single way.....	12
	Cool under pressure.....	12
	HOW TO.....	13
	Install subwoofer.....	13
	Build enclosure.....	15
	Do I need polyfill?.....	17
	TROUBLESHOOTING.....	18
	No power/sound.....	18
	Unwanted noise.....	18
	Distortion.....	18
	WARRANTY & DISPOSAL.....	19
	THE GAS WORLD.....	20



SAFETY

NO COMPROMISES! Especially when it comes to safety. Before installing your MAX S2 series subwoofer, make sure that you read through the manual thoroughly and follow the instructions. Save the manual for future usage and reference!

Make sure to pay attention to the instructions when you see this symbol: 

Do not expose your new subwoofer to excessive damp or moisture. If the subwoofer is exposed it might result in electric failure, shock or damage to the product. Servicing is required when the product has been damaged in any way and/or doesn't operate normally. Refer all servicing to qualified service personnel only.

Keep the cables inside the vehicle separate from sharp edges or components that may be affected or take damage. Follow the recommended cable sizes and always use high quality cables and accessories. Even if you're eager to put the subwoofer to use - take no shortcuts when installing the cables, make sure that all connectors are protected and secured.

Do not drill any holes without checking what lies beneath, and don't cut anything without making sure that no important components risk being damaged.

There is a first time for everything, if you need help - ask a friend or contact your local GAS AUDIO POWER dealer/installer.

We want you to experience your products to the MAX, but we don't want you to injure yourself or others. Use common sense, respect high pressure levels and volume, and follow your local laws and regulations.



UNPACKING

Unboxing your new MAX product is an experience, make sure that the subwoofer and all the accessories are included in the packaging:



Subwoofer



Manual



Speaker cable
(4 pcs)



The speaker cables are directly attached to the subwoofer instead of terminals.

DIMENSIONS

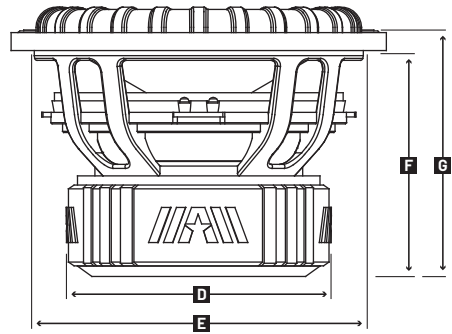
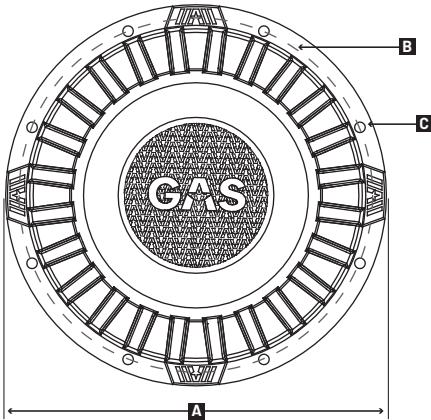

	A	B	C	D	E	F	G	
S2-10D1/D2	Ø275	Ø255	Ø6	Ø230	Ø235	175	190	mm
S2-12D1/D2	Ø326	Ø303	Ø6	Ø230	Ø285	196	212	mm
S2-15D1/D2	Ø396	Ø375	Ø6	Ø230	Ø350	215	231	mm

SPECIFICATIONS

Below you'll find the specifications that has been checked and tested in our workshop. The specified sensitivity isn't directly connected with the sound pressure in the vehicle, and shouldn't be used as the sole indicator for comparison with other subwoofers.

MAX S2-10D1	
Component	Subwoofer
Size	10" (250mm)
Nominal impedance	1+1 Ohm
Power RMS	2000W
Power MAX	4000W
Freq. response	25-200Hz
Voice coil	Dual 3" 4-layer copper wire
Voice coil former	BASV
Cone	Reinforced Mica Pulp Cone
Dustcap	A-Star 3D IMPP
Basket	HD Aluminum
Magnet	3x108oz HQ Ferrite
Suspension	High roll ribbon foam (dual stitch)
Spider	Dual Nomex with Mesh
Tinsel	Dual silver coated leads
Terminal	Pre Terminated 6mm ² OFC wire 80cm
Weight	19 KG

MAX S2-10D2	
Component	Subwoofer
Size	10" (250mm)
Nominal impedance	2+2 Ohm
Power RMS	2000W
Power MAX	4000W
Freq. response	25-200Hz
Voice coil	Dual 3" 4-layer copper wire
Voice coil former	BASV
Cone	Reinforced Mica Pulp Cone
Dustcap	A-Star 3D IMPP
Basket	HD Aluminum
Magnet	3x108oz HQ Ferrite
Suspension	High roll ribbon foam (dual stitch)
Spider	Dual Nomex with Mesh
Tinsel	Dual silver coated leads
Terminal	Pre Terminated 6mm ² OFC wire 80cm
Weight	19 KG

SPECIFICATIONS

MAX S2-12D1	
Component	Subwoofer
Size	12" (300mm)
Nominal impedance	1+1 Ohm
Power RMS	2500W
Power MAX	5000W
Freq. response	20-200Hz
Voice coil	Dual 3" 4-layer copper wire
Voice coil former	BASV
Cone	Reinforced Mica Pulp Cone
Dustcap	A-Star 3D IMPP
Basket	HD Aluminum
Magnet	3x108oz HQ Ferrite
Suspension	High roll ribbon foam (dual stitch)
Spider	Dual Nomex with Mesh
Tinsel	Dual silver coated leads
Terminal	Pre Terminated 6mm ² OFC wire 80cm
Weight	19.8 KG

MAX S2-12D2	
Component	Subwoofer
Size	12" (300mm)
Nominal impedance	2+2 Ohm
Power RMS	2500W
Power MAX	5000W
Freq. response	20-200Hz
Voice coil	Dual 3" 4-layer copper wire
Voice coil former	BASV
Cone	Reinforced Mica Pulp Cone
Dustcap	A-Star 3D IMPP
Basket	HD Aluminum
Magnet	3x108oz HQ Ferrite
Suspension	High roll ribbon foam (dual stitch)
Spider	Dual Nomex with Mesh
Tinsel	Dual silver coated leads
Terminal	Pre Terminated 6mm ² OFC wire 80cm
Weight	19.8 KG

SPECIFICATIONS

MAX S2-15D1	
Component	Subwoofer
Size	15" (380mm)
Nominal impedance	1+1 Ohm
Power RMS	2500W
Power MAX	5000W
Freq. response	20-200Hz
Voice coil	Dual 3" 4-layer copper wire
Voice coil former	BASV
Cone	Reinforced Mica Pulp Cone
Dustcap	A-Star 3D IMPP
Basket	HD Aluminum
Magnet	3x108oz HQ Ferrite
Suspension	High roll ribbon foam (dual stitch)
Spider	Dual Nomex with Mesh
Tinsel	Dual silver coated leads
Terminal	Pre Terminated 6mm ² OFC wire 80cm
Weight	21 KG

MAX S2-15D2	
Component	Subwoofer
Size	15" (380mm)
Nominal impedance	2+2 Ohm
Power RMS	2500W
Power MAX	5000W
Freq. response	20-200Hz
Voice coil	Dual 3" 4-layer copper wire
Voice coil former	BASV
Cone	Reinforced Mica Pulp Cone
Dustcap	A-Star 3D IMPP
Basket	HD Aluminum
Magnet	3x108oz HQ Ferrite
Suspension	High roll ribbon foam (dual stitch)
Spider	Dual Nomex with Mesh
Tinsel	Dual silver coated leads
Terminal	Pre Terminated 6mm ² OFC wire 80cm
Weight	21 KG

PERFORMANCE

THIELE/SMALL PARAMETERS

	S2-10D1	S2-10D2
Impedance	1+10hm	2+2 0hm
Re	1.8 Ohm	3.8 Ohm
Fs	37.8Hz	35.4Hz
Qms	5.54	6.16
Qes	0.37	0.37
Qts	0.35	0.35
Vas	9.1 L	9.5 L
Sd (cm²)	298	298
Mms	286.3 g	311.1 g
Le	1.3 mH	3.46 mH
Xmax	40mm	40mm
dB/SPL	83dB 1W/1M	82dB 1W/1M
BI	18.1	26.7
Driver Vol. Displacement	4.5 L	4.5 L

	S2-12D1	S2-12D2
Impedance	1+10hm	2+2 0hm
Re	2.2 Ohm	3.8 Ohm
Fs	34.8Hz	27.9Hz
Qms	5.28	5.14
Qes	0.45	0.31
Qts	0.42	0.29
Vas	25.0 L	29.2 L
Sd (cm²)	479	479
Mms	305.1 g	357 g
Le	1.16 mH	3.34 mH
Xmax	45mm	45mm
dB/SPL	86dB 1W/1M	85dB 1W/1M
BI	18.2	28.3
Driver Vol. Displacement	4.8 L	4.8 L

PERFORMANCE

THIELE/SMALL PARAMETERS

	S2-15D1	S2-15D1
Impedance	1+1 0hm	2+2 0hm
Re	2.2 0hm	3.8 0hm
Fs	31.0Hz	26.6Hz
Qms	5.44	5.10
Qes	0.49	0.3
Qts	0.45	0.29
Vas	59.5 L	63.8 L
Sd (cm²)	742	742
Mms	382 g	465.9 g
Le	1.20 mH	3.36 mH
Xmax	50mm	50mm
dB/SPL	87dB 1W/1M	88dB 1W/1M
BI	18.2	31.2
Driver Vol. Displacement	5 L	5 L



PERFORMANCE

IMPEDANCE VS FREQUENCY

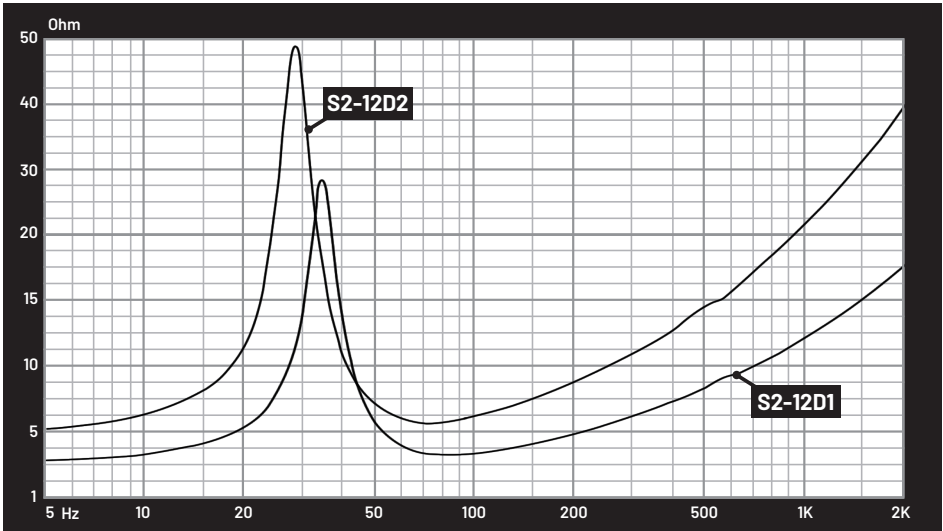
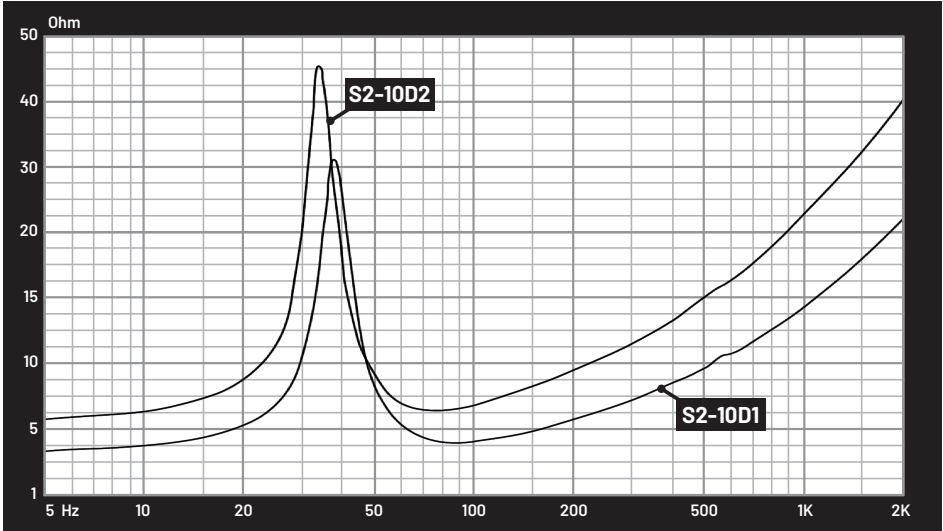

PERFORMANCE

IMPEDANCE VS FREQUENCY

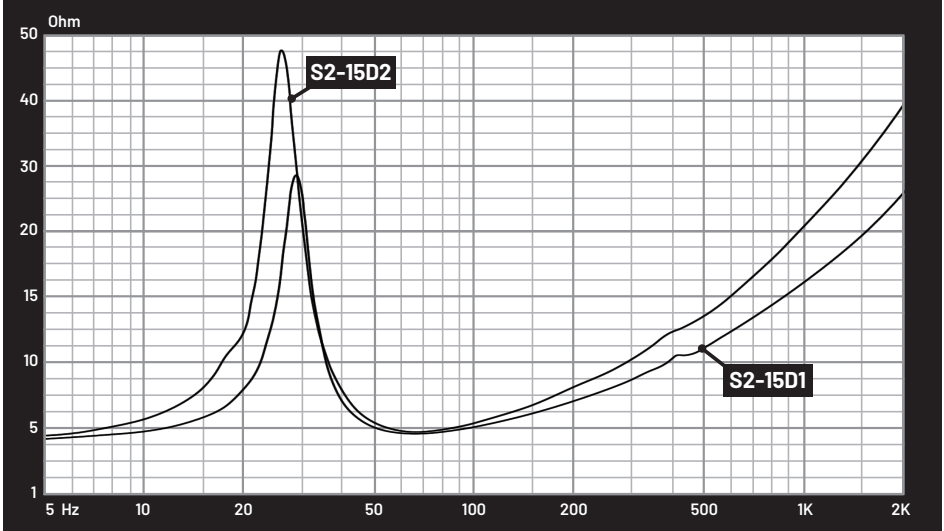

FEATURES

If you have this in your hand, you have taken the next step. You've entered a world of NO COMPROMISES with a subwoofer that will take your car audio to a whole new level. So get out there and shake the foundation to its core! Show them that true dedication comes from the inside of your trunk and that "good enough" never will be enough.

THIS IS WHAT REAL BASS FEELS LIKE

A MAX subwoofer is designed to test the limits and match your dedication in performance and style. To be able to withstand the extreme conditions you surely will put this subwoofer through, the cone is made of non-pressed paper with Mica minerals that excellently balances awesome power, weight and musicality. To handle all of this beautiful bass, we've implemented a T-bone basket that holds vibrations at bay and adds extra stability for the larger models (12" & 15").

TRULY NEXT LEVEL

The dust cap is made of IMPP, an idea we borrowed from the MAD S2 series. But since this is MAX, we took it one step further and reinforced it with fibers. It'll handle everything you throw at it! The impressive high roll ribbon foam suspension gives you even more awesome cone movement. This cone is simply made to move! The 3-inch dual black coated BASV voice coil wire is made of PCW (Pure Copper Wire) and will make sure the subwoofer handles both an insane amount of power and heat. To give you an unmatched connection, we've added four 6mm² pure OFC copper (direct tinsel terminated) speaker cables instead of old fashioned terminals.

IMPRESSIVE IN EVERY SINGLE WAY

The MAX S2 series will make jaws drop. We show our dedication to the craft of bass with triple stacked HQ ferrite magnets to achieve a truly mind-blowing amount of motor in the subwoofer. We've added a Dual Nomex spider with orange mesh technology and dual stitching for extra durability, to make sure that the last thing standing will be your sound system. Is this enough for you? We doubt it. To add even more durability and flexibility we've added a woven web to the spider, for extra strength and style!

COOL UNDER PRESSURE

The MAX S2 will show everyone that you have reached the next level, the MAX level. Having a subwoofer perform at this level demands extremely good ventilation. Only the best and beyond is good enough! We solved the cooling in two different ways. The material in the top/back plate is thicker for optimal heat conduction, and the implemented DVS2 (Dual Ventilation System) creates incredible heat dissipation while also reducing distortion.

HOW TO

INSTALL SUBWOOFER

Before installing your brand new subwoofer, make sure that you have everything you need. Have the right tools ready, and make sure that you have the necessary knowledge/skill to perform the installation properly. Preparation and knowledge is crucial!

The MAX S2-10D1/S2-12D1/S2-15D1 uses dual 1 Ohm voice coils, while the MAX S2-10D2 /S2-12D2/S2-15D2 uses dual 2 Ohm voice coils. If you want to connect two or more S2 series sub-woofers, you can vary the impedance by altering the wiring configuration to use a series, parallel or series-parallel setup. The more the merrier!

Make sure to look through the recommended wiring schematics below and choose the setup that corresponds with the number of subwoofers in your sound system. Take note of the impedance stability of your amplifier. Don't be afraid to consult your local GAS AUDIO POWER dealer/installer if you have any questions.

 It is important to know the limits of your amplifier. Be sure to connect your sound system with a suitable impedance to optimize your sound system.

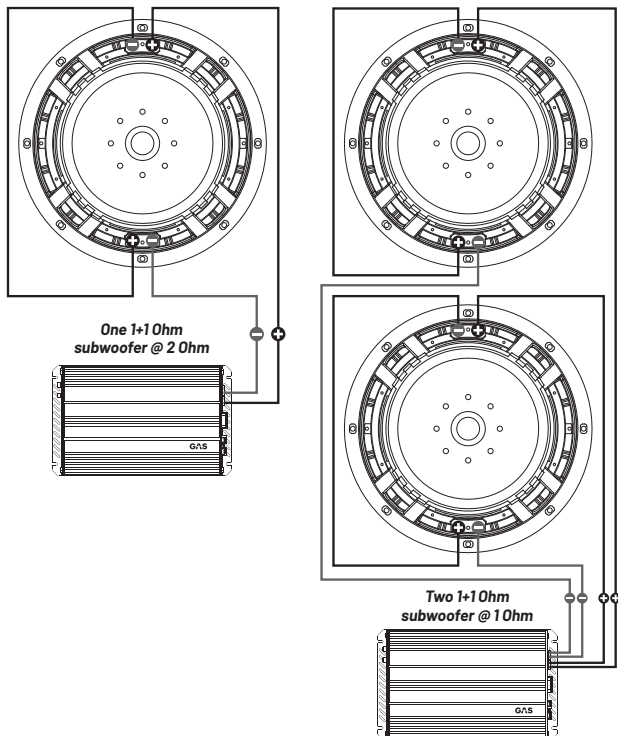

HOW TO

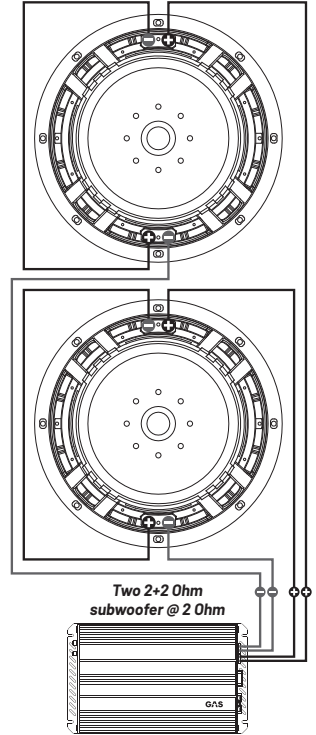
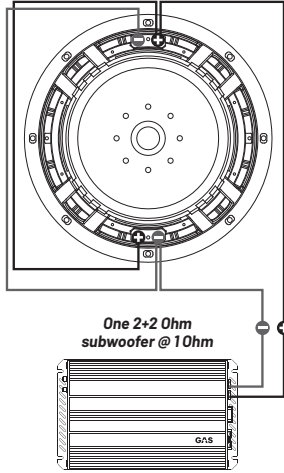
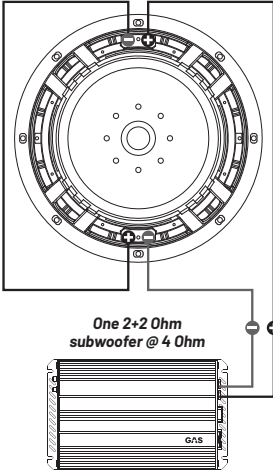

⚠ It is important to know the limits of your amplifier. Be sure to connect your sound system with a suitable impedance to optimize your sound system.

HOW TO

BUILD ENCLOSURE

If you want a LOUD and awesome looking sound system, you should mount your MAX subwoofer in an enclosure. Here's information about optimized volumes for different types of enclosures and how they perform with the MAX S2 subwoofer. If you feel unsure about how to build an enclosure on your own, consult a local GAS AUDIO POWER dealer/installer.

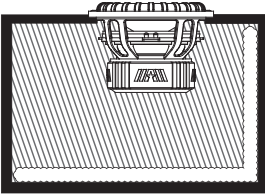

SEALED

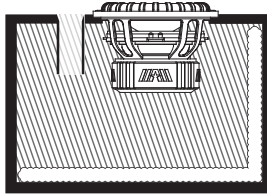

VENTED

MAX S2-10D1/D2:

	VOLUME	F3	QTC	FB	PORT	LENGTH	POLYFILL
VENTED	39L*	34.5Hz	x	40Hz	1x4" (104mm)	400mm	Mini
VENTED	45L*	34.5Hz	x	40Hz	Slot 1200cm ²	545mm	Mini

* Driver displacement volume included

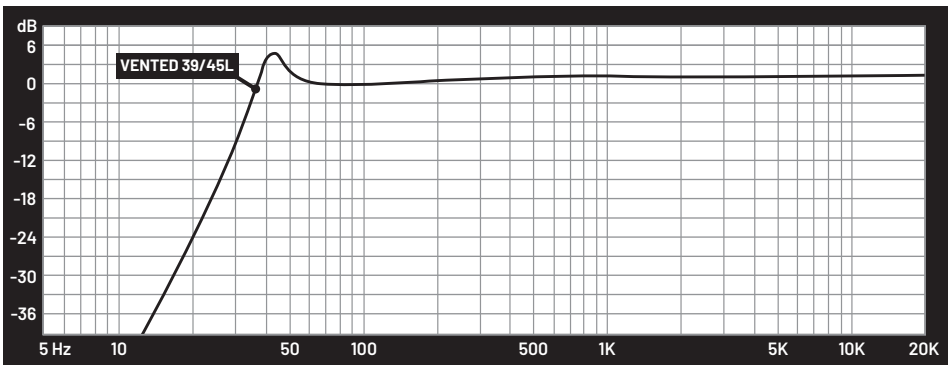

HOW TO

MAX S2-12D1/D2:

	VOLUME	F3	QTC	FB	PORT	LENGTH	POLYFILL
VENTED	58L*	34Hz	x	40Hz	Slot 1400cm ²	420mm	Mini
VENTED	59.5L*	37Hz	x	45Hz	1x6" (155mm)	444mm	Mini

* Driver displacement volume included

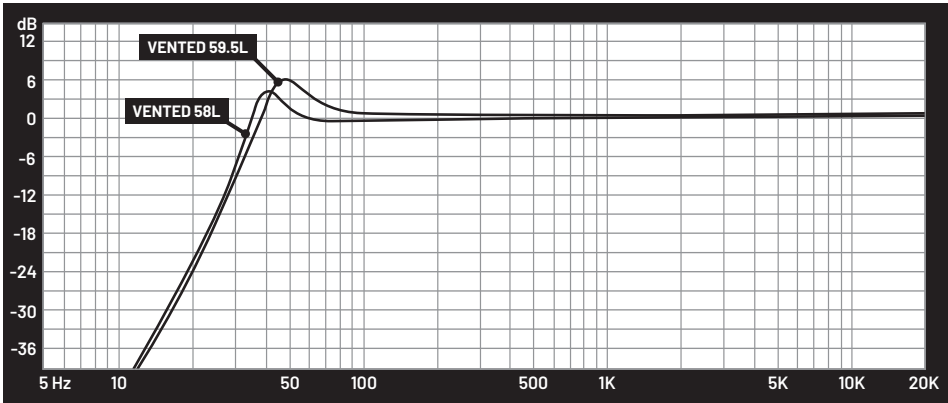

HOW TO

MAX S2-15D1/D2:

	VOLUME	F3	QTC	FB	PORT	LENGTH	POLYFILL
VENTED	79.5L*	32.5Hz	x	38Hz	1x6" (155mm)	444mm	Mini
VENTED	85*	31Hz	x	35Hz	Slot 2000cm ²	580mm	Mini

* Driver displacement volume included

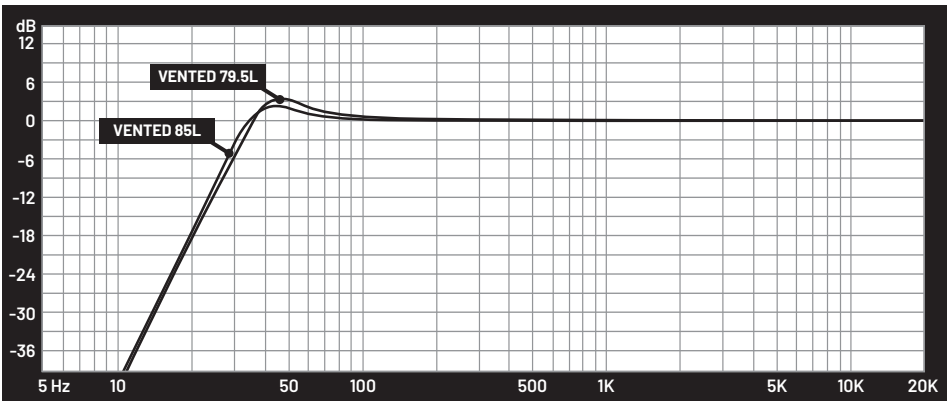

DO I NEED POLYFILL?

Hell yeah! We recommend using polyfill for all sealed, vented and bandpass enclosures for the best overall performance.

A polyfilled enclosure will bring out the full potential of your subwoofer, by starting an isothermal process when energy flows through the fibers (very scientific). This means that the air gets more dense, so it lessens the BOOM and brings out the BASS! It can also reduce harmonic distortion. Sounds complicated, we know. But it's easy to do! Cover two sides in a ported enclosure or make a loose polyfill ball behind the driver in a sealed enclosure. Try it out! If you like the bass to hit harder - just take away some. Do you want to lessen the effect? Put in some more.

TROUBLESHOOTING

NO POWER/SOUND

Check the subwoofer to make sure it isn't damaged. If your subwoofer doesn't get any power, the most common issue is either in the wiring or in the amplifier. Use a multimeter to measure the amplifier's voltage on the +12V terminal and the remote signal terminal. Use a multimeter to make sure that you have a negative ground connection. Check the built-in fuse (if there's one) on the amplifier. If there's no power coming through - control the fuse on the power cable. If this is intact - make a full check of the wiring to ensure cable integrity.

Check all the speakers connected to your sound system. Check all the speaker cables and all the signal cables. Check your head unit to make sure no settings are limiting the amplifier's functions or the subwoofer. When all of the above has been tested/looked over, and all is as it should be but there's still no sound, consult your local GAS dealer.

UNWANTED NOISE

Start by looking over the subwoofer and other speakers in the sound system so there is no damage or connection issue with the wiring. Make sure that your signal cables or speaker cables aren't too close to the power cables. Check your amplifier's grounding point and make sure that the surface is clean. When all of the above has been tested/looked over, and the unwanted noise does not vanish, consult your local GAS dealer

DISTORTION

Start by looking over the subwoofer and other speakers in the sound system so there's no damage or connection issue with the wiring. Check the speaker cables to make sure that the polarity isn't reversed on one channel. Check the settings on the amplifier, make sure that the gain/level is set according to the amplifier's instructions. If your amplifier has a boost function, lower its effect or turn it off.

WARRANTY & DISPOSAL

This product is covered by warranty, depending on the conditions in the country where it's sold. If the subwoofer is returned for service, please include the original dated receipt (or a copy) with the product. Make sure that the subwoofer is packaged properly and secured, preferably in its original packaging.



The crossed-out wheeie bin symbol means that the product, literature and packaging included must be taken to separate collection at the end of their working life. Don't dispose of these products as unsorted municipal waste: take them for recycling. For info on your nearest recycling point, check with your local waste authority.



This product has been granted with the CE certification mark to show that the product follows the health, safety, and environmental protection standards for products sold within the European Economic Area (EEA).



GAS Audio Power products comply with the relevant provisions of the RoHS Directive for the European Union. In common with all Electrical and Electronic Equipment (EEE) the product shouldn't be disposed of as household waste. Alternative arrangements may apply in other jurisdictions.



GAS Audio Power is a global partner of the European Mobile Media Association, an organization that focus on promoting the custom made mobile media installations to consumers.

THE GAS WORLD

You've entered the world of GAS. We aim to please, and we've made sure to have products made for you. No matter what stage of the LOUD-addiction you might find yourself in, there is a GAS product to fill your need.

MAD

Just starting out? The MAD series is made to play LOUD and to be the express lane to a no bullsh!t sound system that will make sure everyone can hear you coming!

MAX

The MAX series holds products made to deserve the center stage. Powerful, heavy duty and designed to be noticed. We made NO COMPROMISES because we know that you wouldn't accept it.

CMP

The CMP series has been developed for the crucial seconds when the dB-counter starts to tick. All CMP products have hand-picked, high quality, COMPETITION GRADE components and they are specially designed to withstand an awesome amount of power.



THANKS FOR JOINING GAS AUDIO POWER!



GAS

AUDIO POWER

GAS AUDIO POWER and SHAKY are registered trademarks by Winn Scandinavia AB and is protected by relevant laws and jurisdictions such as Copyright and Trademark laws.

Winn Scandinavia AB | Elementvägen 15, 70227 Örebro, Sweden | www.winnscandinavia.com

Winn Scandinavia AB reserves for possible typos, factual or numeric errors that may have been printed on any products, package designs, user manuals and/or other included accessories.



GAS

GAS
AUDIO POWER